

# Tray for Charging Station Tower

## ASSEMBLY INSTRUCTIONS

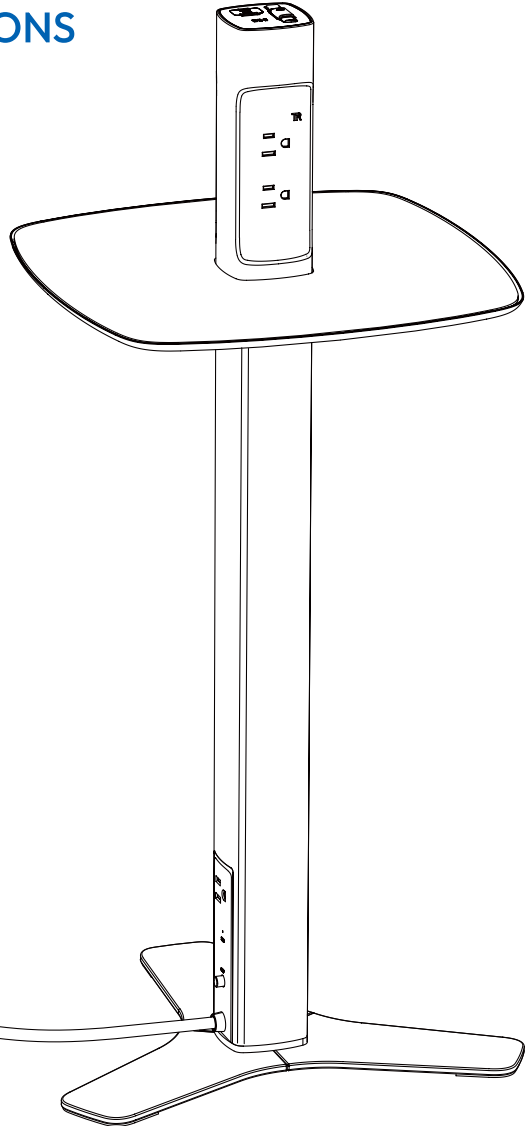

\*Note: The Freestanding Charging Station Tower is not included and must be purchased separately.

# Reliable energy for every workspace.

Online Assembly Video



**FRIANT**

# Components

## Hardware

A

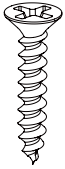

Bracket Fixing  
Screws  
2 pcs

B



Tray Fixing  
Screws  
4 pcs

## Tool

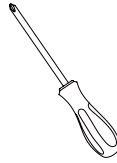

Screwdriver  
3mm  
1 pc  
(included)

## Main Parts

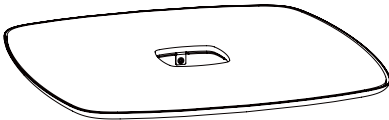

C  
Tray  
1 pc

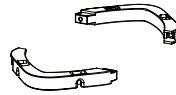

D  
Bracket  
2 pcs

# 1

Secure the two Brackets (D) to the main post, just below the outlets. Use (A) screws to connect the two Brackets together.

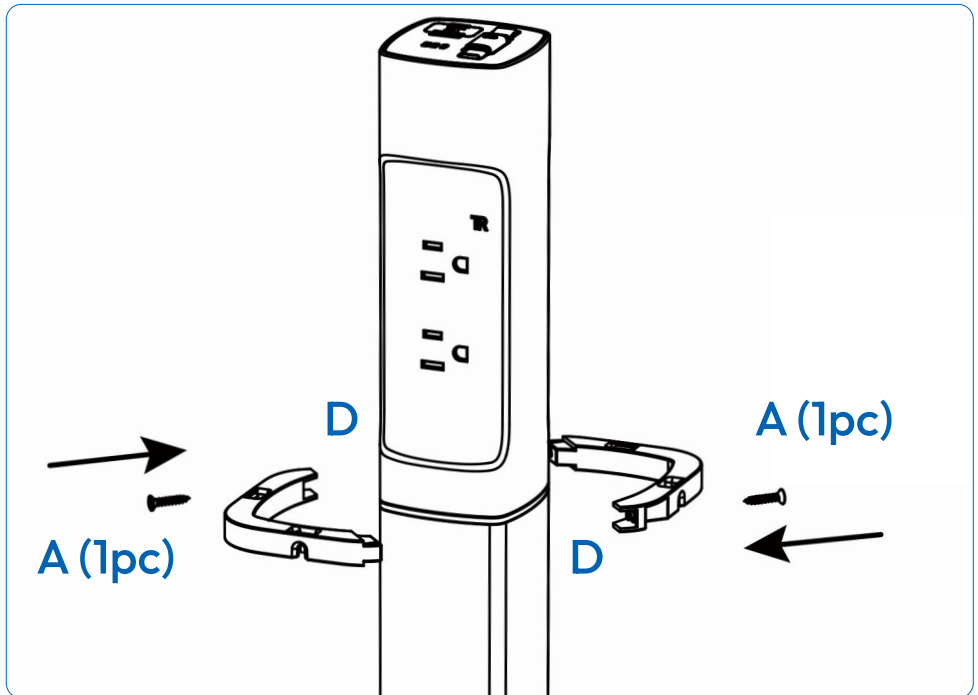

# 2

Once the Bracket are connected, slide the Tray (C) downward onto the main body and rest it on top of the Brackets. Use four (B) screws to secure the Tray to the Brackets.

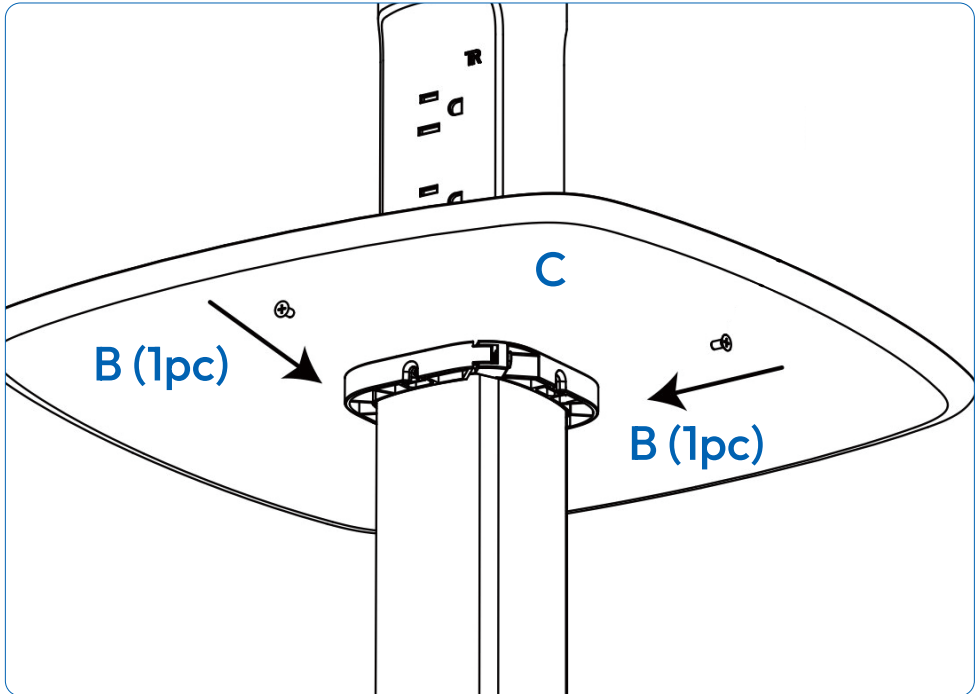

# All done!

Nice work—you've just powered up your space with Friant Plus.

Now set your devices down and charge with ease.

# Friant has everything you need to build your entire office.

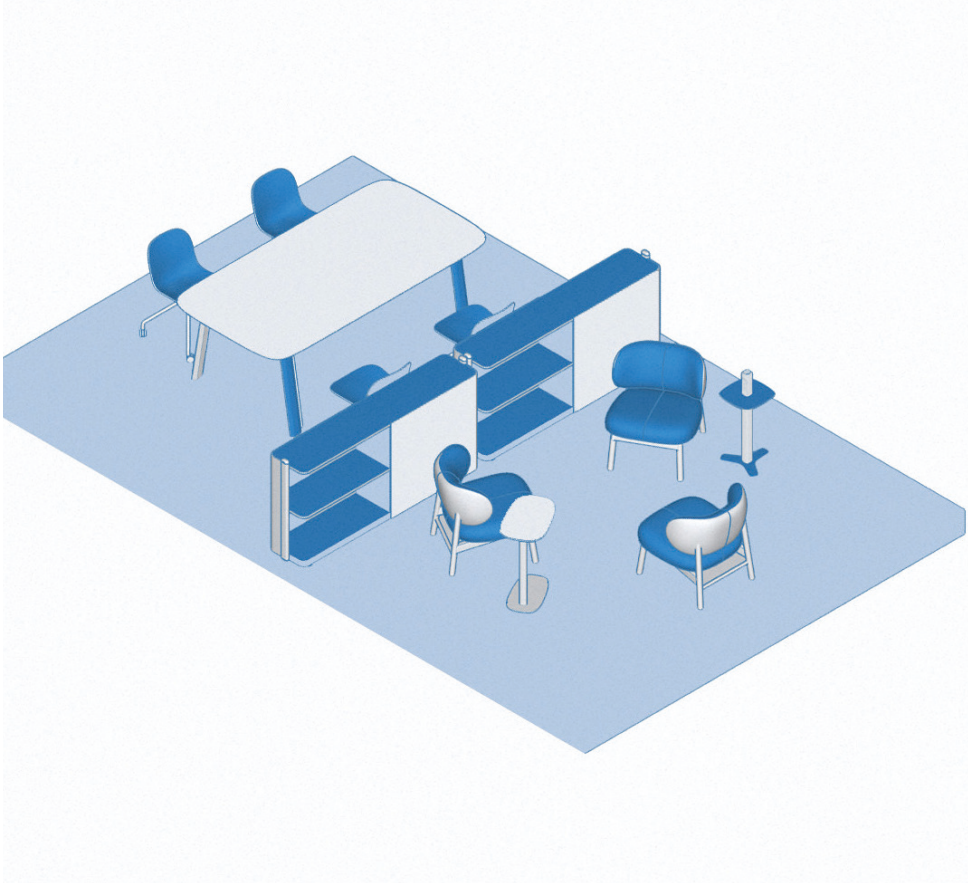

For more than 30 years, Friant has been creating high-quality office furniture to meet the needs of every workspace.

Made from the finest materials, our high-quality, durable, and stylish products are the building blocks of productivity.

Friant Plus now brings our craftsmanship online, offering exclusive access to products not found in typical retail stores.



## **Contact**

Have questions, comments, or need support?

Email: [support@friantplus.com](mailto:support@friantplus.com)

Website: [www.friantplus.com](http://www.friantplus.com)