

Bar Height Plastic High Chair with Sled Legs

ASSEMBLY INSTRUCTIONS

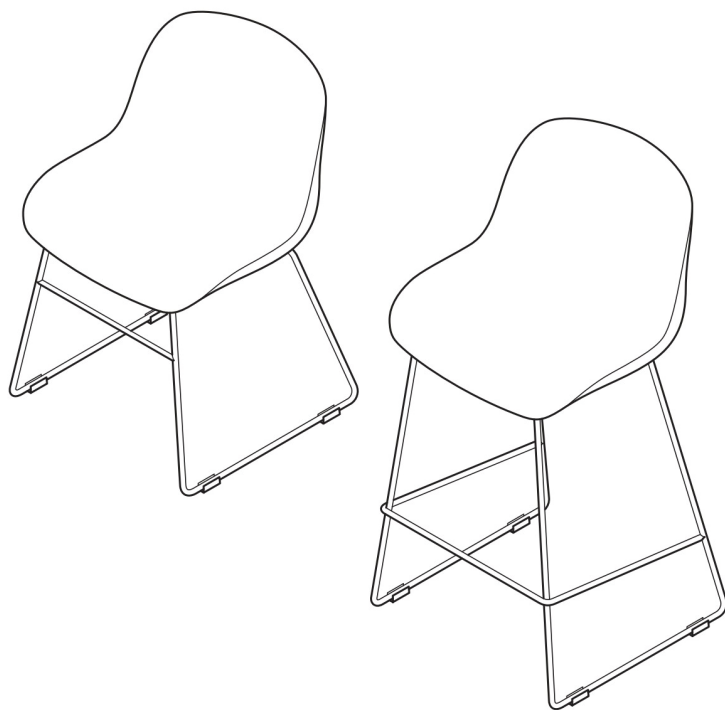

FRIANT

**Built high for
conversation and
connection.**



Components

Main Parts

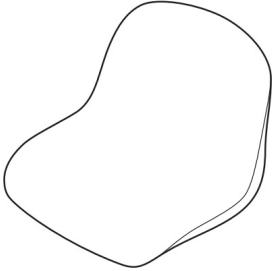
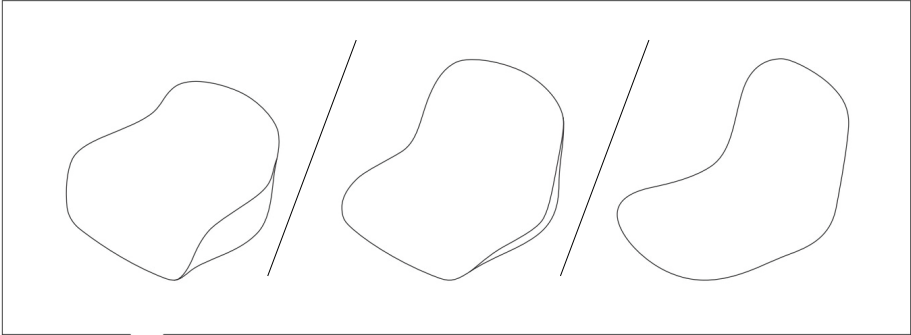

A
Seat-Back Unit
1 pc

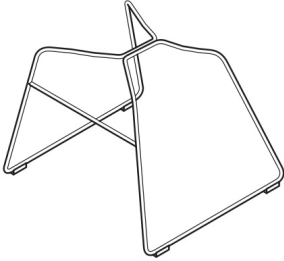

B
Sled Base Frame
1 pc

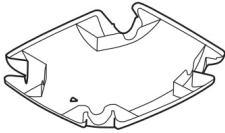

C
Click-On Cover
1 pc

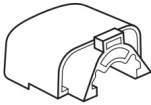
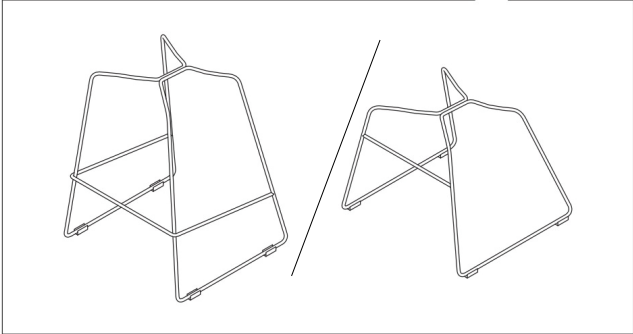

D
Frame Connector
4 pcs

1

Let's start with the frame. Grab the Seat-Back Unit (A) and the Sled Base Frame (B). Snap the frame tubes into the grooves on the Seat-Back Unit (A).

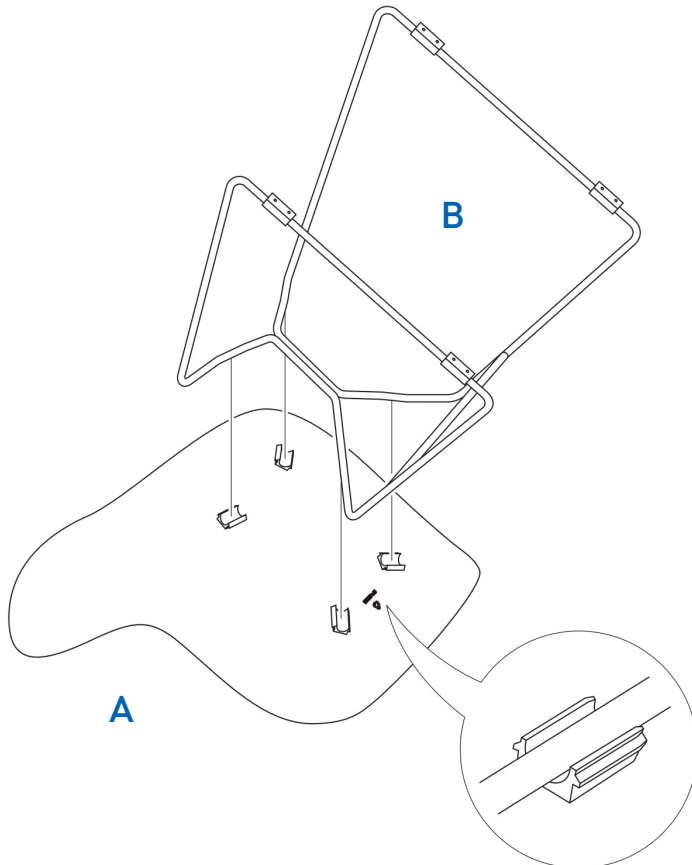

2

Then, use a rubber mallet to gently tap the four Frame Connectors (D) into the slide grooves.

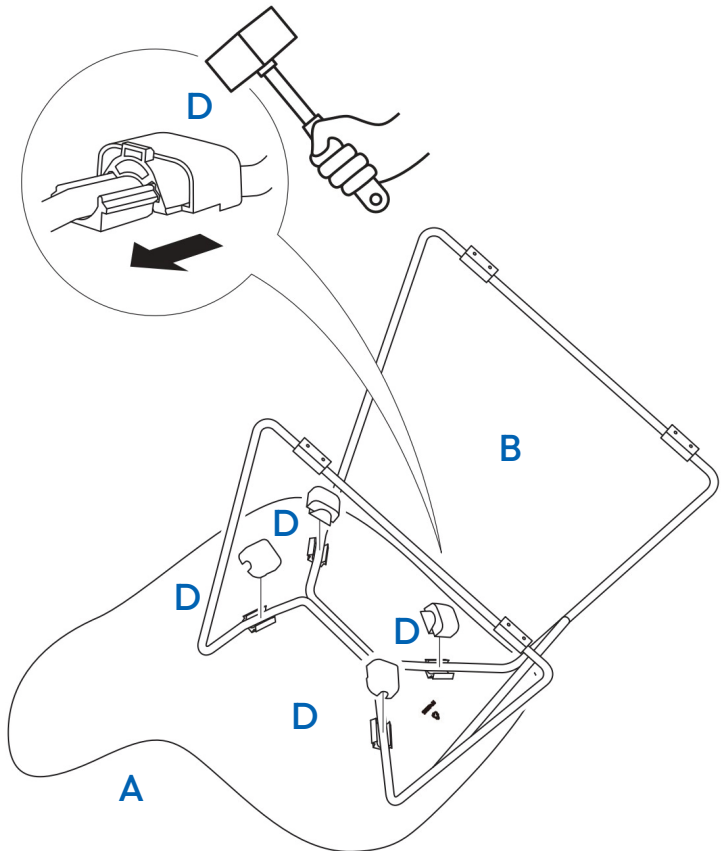

3

Next, take the Click-On Cover (C) and align its four notches with the four connectors. Make sure the mark on the cover is aligned with the mark on the underside of the Seat-Back Unit (A), or that the angled side is facing the front of the seat. Click it in place, flip over the chair, and relax!

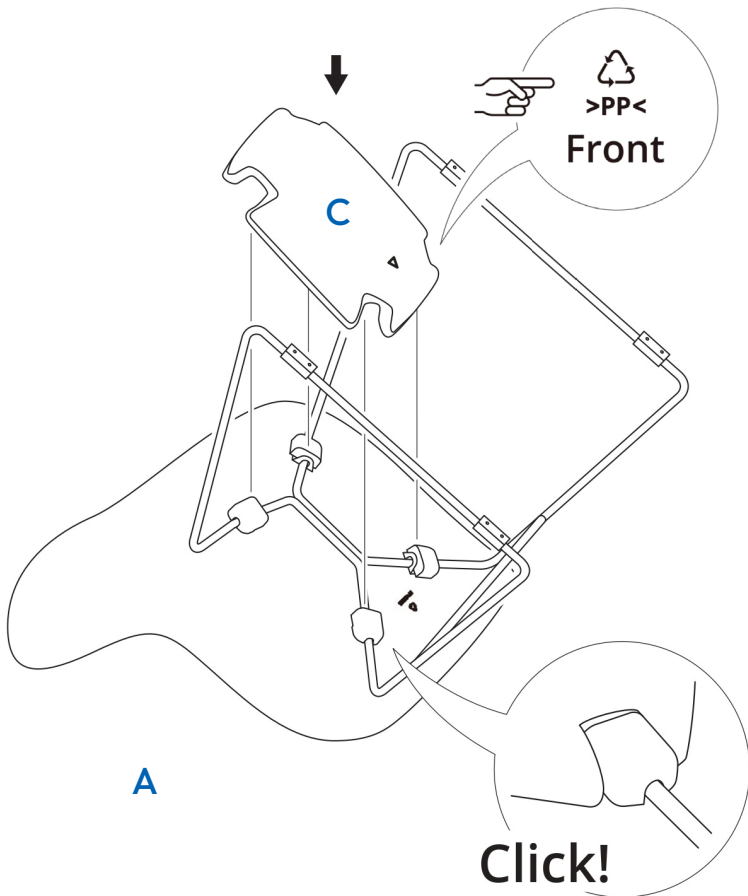

All Done!

Nice work—you've just added ease and versatility to your space with Friant Plus.

Now take a seat, unwind, and enjoy the moment.

Care Instruction

1. Clean gently with a moist cloth.
2. Do not use harsh chemicals.
3. Do not expose to high heat.



Friant has everything you need to build your entire office.

For more than 30 years, Friant has been creating high-quality office furniture to meet the needs of every workspace.

Made from the finest materials, our high-quality, durable, and stylish products are the building blocks of productivity.

Friant Plus now brings our craftsmanship online, offering exclusive access to products not found in typical retail stores.

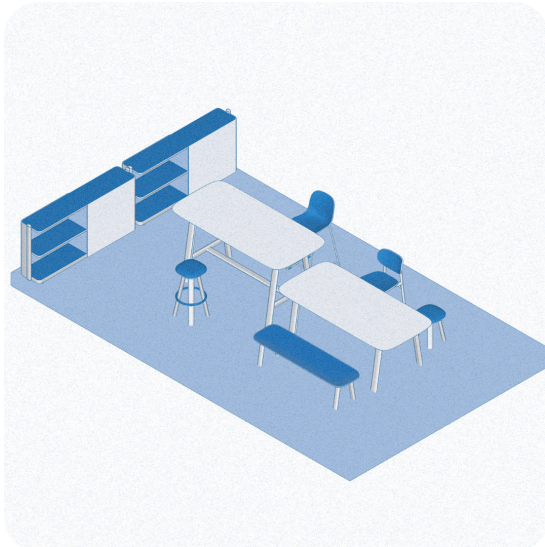

Contact

Have questions, comments, or need support?

Email: support@friantplus.com

Website: www.friantplus.com